

ZA3

DIMENSIONS (in mm)

Without rubber cap

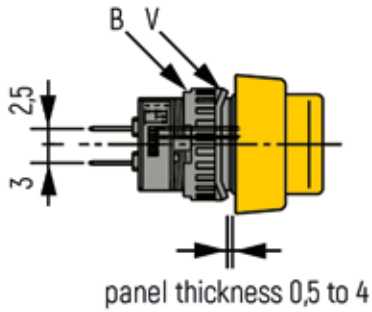

With rubber cap

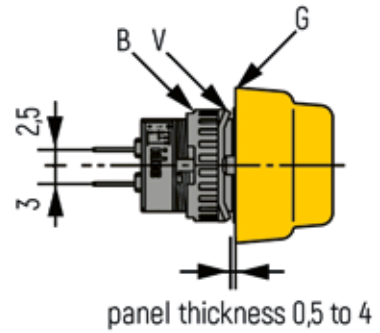

B: Mounting nut | G: Rubber cap | V: Turning protection

